



# Specification

## 1. Model Number:

HCL-T806P10S3X-UL-X

### Remarks:

- "06" stands for length 60cm.
- The 1<sup>st</sup> "X" stands for color temperature, W means warm white, N means natural white, P means pure white, C means cool white.
- The 2<sup>nd</sup> "X" stands for cover, C means clear cover, F means frosty cover.



2. Picture:

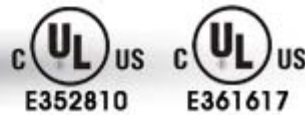

3. Dimension(Unit:mm,±0.5mm):

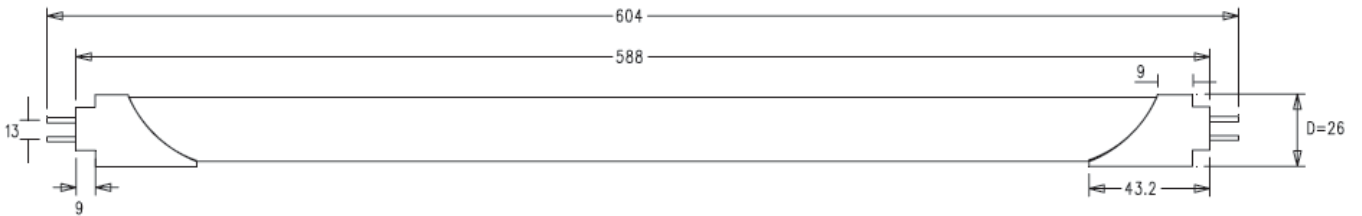

4. Intramural electro circuit:

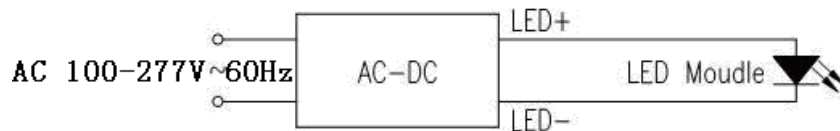

5. Driving(test) circuit:

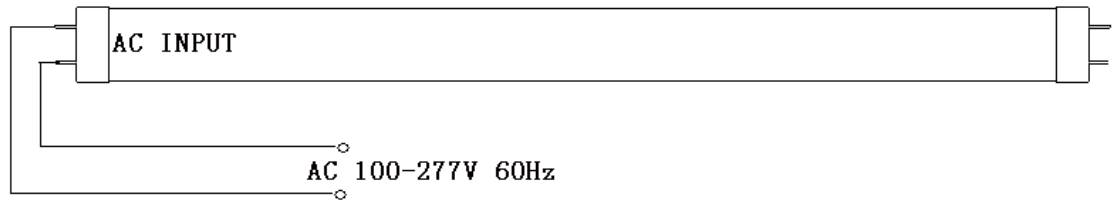

## 6. Technical data:

| Parameter               | symbol | Data  | Unit   |
|-------------------------|--------|---|--------|
| Size                    | Ø x L  | Ø26 x L604  | MM     |
| Power Consumption       | W      | 10  | W      |
| Input Voltage           | V      | AC100 -277V 60Hz  | --     |
| * Luminous Flux         | Flux   | 1000  | Lm     |
| LED Type/Q'ty           | --     | 60pcs 2835 SMD  | --     |
| * Color Temperature     | Tc     | Warm white: 2700-3300<br>Natural white: 3900-4600<br>Pure white: 4900-5800<br>Cool white: 6000-7200 | K      |
| * Color Rendering Index | Ra     | 70  | --     |
| Beam Angle              | --     | 120   | Deg(°) |
| Body Temperature        | --     | ≤55℃ (at room temperature 28℃)  | ℃      |
| Operation Temperature   | --     | - 20~+40  | ℃      |
| Base                    | --     | G13   | --     |
| Outer Housing Material  | --     | Aluminum + PC   | --     |
| IP grade                | --     | 54  | --     |

Remark: \* The data above are base on the Wattage (10W)

## 7. Usage:



• With Inductive ballast

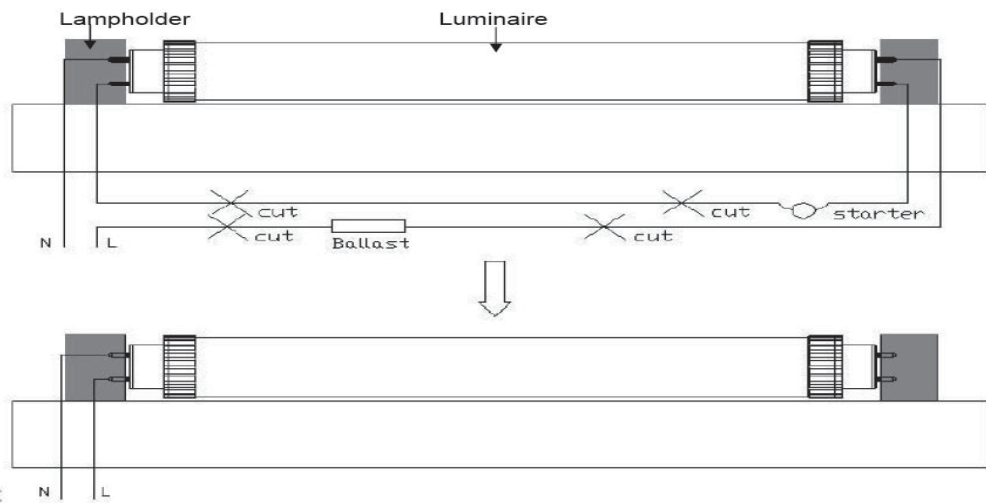
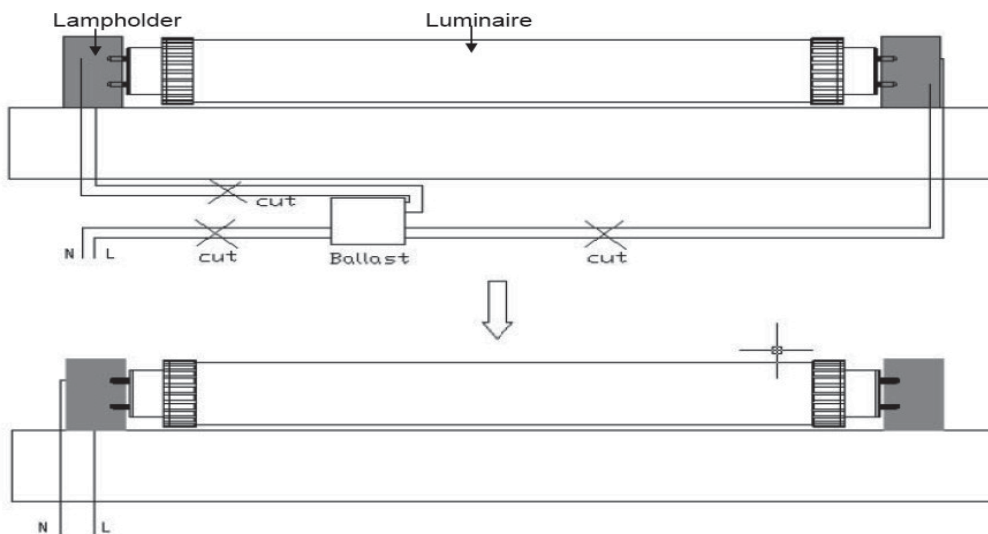

Fig.1

• with electronic ballast



8. Cautions:

- The working input voltage for this product is AC100 -277V 60Hz, please ensure the right voltage before running, wrong voltage may cause permanent damage.
- To prevent electric shock, do not touch the metal parts on the ends after connecting electricity.
- Please check it before using, if there are any breakages, please notify your supplier.
- Do not touch the light when it's working.
- Shut off the power before replacing the light.

9. Packing:

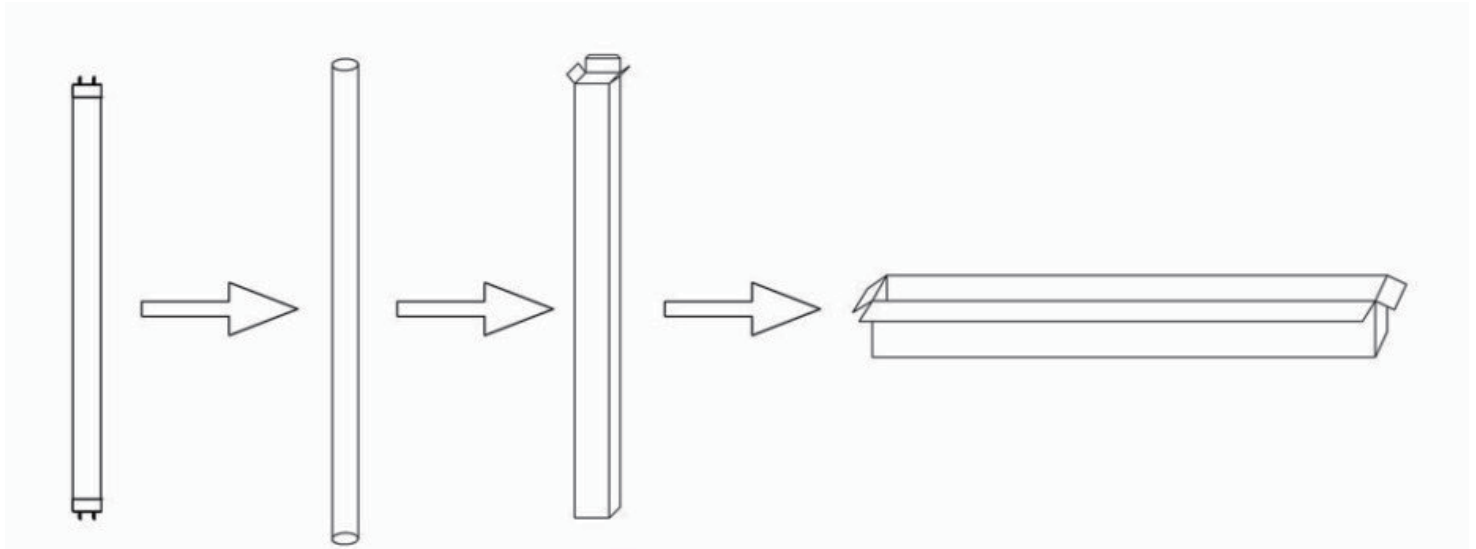

- 1pc/polybag/strong round box
- Q'ty/Carton: 50pcs
- Carton size: 1250x210x220mm

**10. cULus listed, file No. E352810, E361617.**